



APLIWELD® Secure+

Exothermic welding manual



APLIWELD® Secure+

Exothermic welding
manual



Index

A. General safety measures in exothermic welding procedures	6	F.2 Lack of welding material in the final result	54
A.1 Safety instructions	7	F.3 Material leakages through the conductors	55
B. How to make APLIWELD® exothermic weldings	8	F.4 Too much slag stuck to the welding surface	56
B.1 Procedure using electronic device: APLIWELD® Secure+	8	F.5 Electronic ignition trouble-shooting	57
B.2 Procedure using the spark lighter	14	F.6 Spark lighter/manual ignition shooting	58
B.3 Multiple mould. Procedure using electronic device: APLIWELD® Secure+	20	F.7 Handle-clamp doesn't hold the mould tight	60
B.4 Multiple mould. Procedure using the spark lighter	28	F.8 Correspondence between AT-020N tablets and traditional welding material	61
C. Moldes APLIWELD®	36	F.9 Metalic surface conections	62
C.1 APLIWELD® mould codes and labelling	36	F.10 Re-bar connections	62
C.2 Conductors dimension tables	38	F.11 Vertical earth rod or re-bar connections	63
C.3 Basic tool set: AT-069N	40	F.12 Other material impurities	64
C.4 Multiple mould containing & spare parts	42	G. Reference index & common product codes	66
C.5 Multiple mould connections	44	H. Enviroment	70
C.6 Cleaning and maintenance	46	H.1 Indications for use and recommendations for recycling equipment lead batteries electronic ignition AT-114N	70
C.7 Mould inspection	48	i. Warnings, guarantees & limitation of liability	72
D. APLIWELD® tablets and consumables	50	i.1 Warnings	72
D.1 Tablets and starters	50	i.2 Guarantees	72
E. Welding check-up	52	i.3 Limitation of liability	73
E.1 Acceptable or unacceptable results	52		
F. FAQ's & resolution tips	54		
F.1 Pinholes on the welding surface	54		



A. General safety measures in exothermic welding procedures

For a suitable and safety installation work, **APLIWELD® products must be used in conformance to this manual or in each particular product instructions, all available in www.at3w.com.**

Should you require more information about the welding processes or in case of any doubt, mail us to atsa@at3w.com or call to **+34 96 131 82 50**.



A.1 Safety instructions

- ▶ Read carefully the particular product instructions supplied in all APLIWELD® products before its use. Personal should be properly trained according to NTP1028.
- ▶ Do not breath reaction fumes.
- ▶ After one welding, wait 4-5 minutes before igniting the next one, right to avoid mould overheating.
- ▶ Do not connect items except as detailed in instruction sheets or in this manual.
- ▶ Do not use worn or broken equipment. These could cause material leakages, unacceptable or unsafe connections, personal injuries and property damage.
- ▶ Do not modify APLIWELD® equipment or material without technical authorization. Consult APLICACIONES TECNOLÓGICAS S.A. technical department.
- ▶ Safety gloves and glasses are required.
- ▶ Avoid contact with hot materials. The exothermic process reaches temperatures in excess of 1500°C.
- ▶ Welding material is not considered as explosive.
- ▶ Welding and electronic ignition material are non-explosive.
- ▶ Remove/minimize fire hazards in the working area.
- ▶ Do not smoke when handling and using APLIWELD® products.
- ▶ Avoid direct visual contact when “flashing” ignition occurs (using starting powder).
- ▶ In case of fire, use of water or CO₂ will aid in control of burning containers. Large quantities of water will aid in controlling a fire if the exothermic materials become involved. Water should be applied from a safety distance.
- ▶ Avoid moisture in moulds and conductors, since contact between hot molten metal and moisture or contaminants may result in material leakages or wrong welding results.



B. How to make APLIWELD® exothermic welding

B.1 Procedure using APLIWELD® Secure+ electronic ignition

1 Clean and remove any impurities off the mould or conductors.

Conductors and mould have to be clean and dry. This is very important to avoid rejectable welding and hazardous reactions (material leakages) when melting copper contacts moisture or impurities.

Clean conductors using **AT-061N** brush.

Check F.9, F.10, F.11 and F.12 in this manual for particular surfaces or conductors cleaning indications.



2 Heat the mould.

Heat the mould always before the first welding of the day or when the mould is not hot enough. Heat it up to 120°C.

This is a very important step in order to reach an acceptable result for first welding but also makes the reaction more safety for the user.

Moisture could cause material leakages out of the mould and pinholes in the welding result. Graphite gets moisture from the environment at ambient temperature, so it is necessary to heat it above water boiling point.



3 Fit the conductors in the mould and close the handle clamps.

Check if the mould is tightly closed. Also, the conductors must be fixed and well positioned.

If conductors doesn't fit or they lose-fit in their cavities, it could be because their sections are not the standards.

Find in the C.2 section the machined standard dimensions for the conductors in APLIWELD® moulds. If you have any doubt, do not hesitate to contact us.



4 Set the proper number of tablets in the crucible.

Place one metallic disc (included on each starting case or powder box) to cover the tap hole. The number of tablets required for a particular connection is engraved on the mould surface as it is in the packaging label.

Find in C.1 section the keys for the mould codes and how to get the right number of tablets for each one.





B. How to make APLIWELD® exothermic welding

B.1 Procedure using APLIWELD® Secure+ electronic ignition

5 Close the mould cover and place the electronic starter.

After closing the mould lid, place the Electronic Starter (**AT-010N**) case in its position and fix it using the security lever.

This security lever ensures good electrical contact and easy work conditions.



6 Open the Ignition Unit and connect the plugs.

Connect the plugs in the device as showed in the picture. The Electronic Starter has no polarity so the order of connection is irrelevant. Connect the other side of the cable to the lateral part of the mould. Fix the clamp to the spike of the Electronic Starter.

The electric contact between the clamp and the spike is essential. The clamp must not touch any other part of the cover. If the clamp becomes worn, just replace it (**AT-100N kit APLIWELD®-E includes 5 of these clamps**)



7 Keep away from the mould and switch on the Ignition Unit.

Stay at least as far from the mould as the connection cable allows (2m).

Switch on the device pressing On/Off button. A beep sound indicates it is ready. Then a green light signal is also displayed.

In order to increase the security of the user, activate the remote-control device and wait until the blue light of the ignition device stops blinking, then the Bluetooth system is connected.



8 Press both ignition buttons simultaneously until the welding process starts.

Press both ignition buttons at the same time (either from the electronic device or the remote control).and keep both pressed till the reaction triggers on.

The welding in process indicator will light on and an audible alarm will activate: two beeps of approx. 3 seconds and then a continuous tone. During this last sound the welding reaction will ignite.

Consult section F.5 in case ignition doesn't occur.



B. How to make APLIWELD® exothermic welding

B.1 Procedure using APLIWELD® Secure+ electronic ignition

9

After the reaction, wait during 15 seconds and open the mould.

Wait 15 seconds before opening, assuring the melting of the materials.

Open the mould cover using the appropriate handle clamps and safety.

gloves, since the whole system is very hot. Keep extreme caution.

Take the welded conductors out of the mould.



10

Cleaning the mould.

Use the right cleaning tools to remove the slag and clean the crucible. **AT-064N** is the appropriate brush to clean the welding cavity. Use **AT-062N** brush to clean the mould cover, especially the Electronic Starter cavity.

Find a detailed description of cleaning tools and how to use them on section C.6 in this manual.



All cleaning tools are included in **AT-069N Tool Set**.

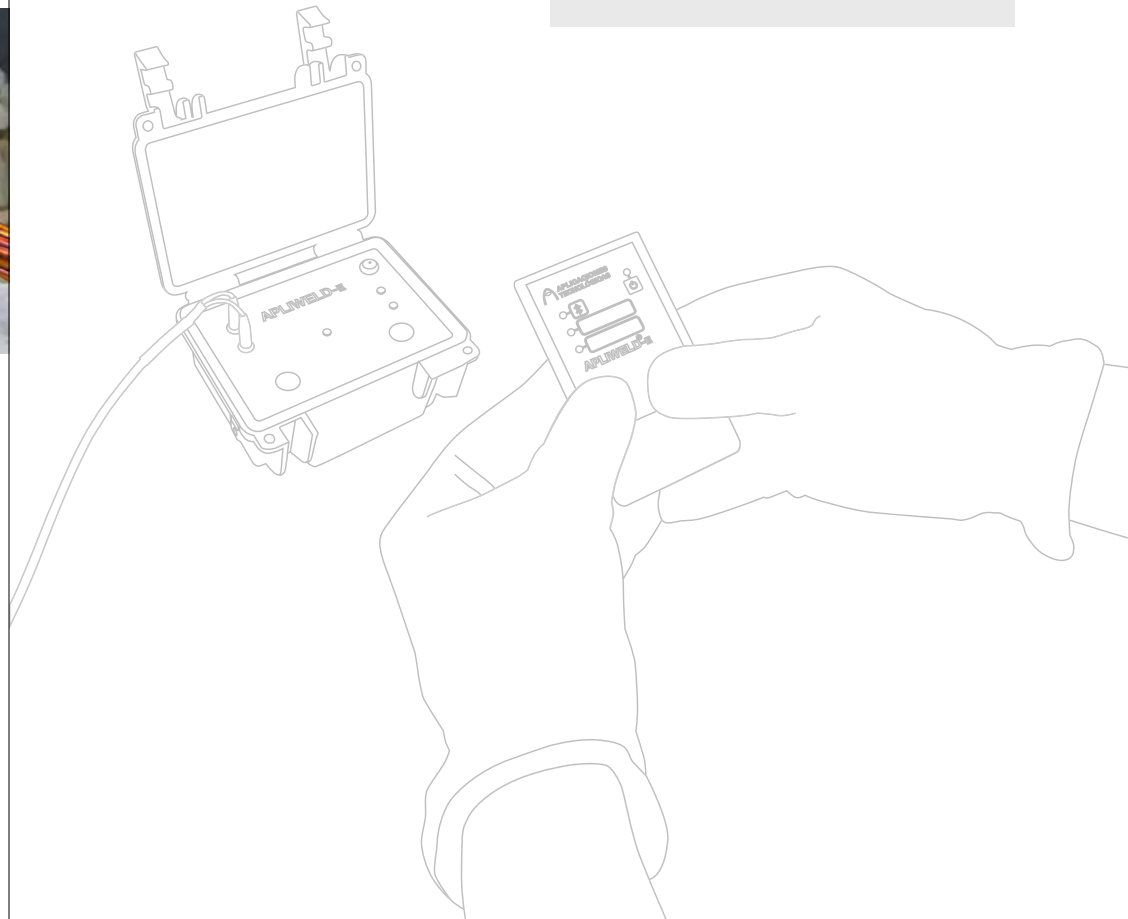



B. How to make APLIWELD® exothermic welding

B.2 Procedure using the spark lighter

1 Clean and remove any impurities off the mould or conductors.

Conductors and mould have to be clean and dry. This is very important to avoid rejectable welding and hazardous reactions (material leakages) when melting copper contacts moisture or impurities.

Clean conductors using **AT-061N** brush.

Check F.9, F.10, F.11 and F.12 in this manual for particular surfaces or conductors cleaning indications.



2 Heat the mould.

Heat the mould always before the first welding of the day or when the mould is not hot enough. Heat it up to 120°C.

This is a very important step in order to reach an acceptable result for first welding but also makes the reaction more safety for the user.

Moisture could cause material leakages out of the mould and pinholes in the welding result. Graphite gets moisture from the environment at ambient temperature, so it is necessary to heat it above water boiling point.



3 Fit the conductors in the mould and close the handle clamps.

Check if the mould is tightly closed. Also, the conductors must be fixed and well positioned.

If conductors doesn't fit or they lose-fit in their cavities, it could be because their sections are not the standards.

Find in the C.2 section the machined standard dimensions for the conductors in APLIWELD® moulds. If you have any doubt, do not hesitate to contact us.



4 Set the proper number of tablets in the crucible.

Place one metallic disc (included on each starting case or powder box) to cover the tap hole. The number of tablets required for a particular connection is engraved on the mould surface as it is in the packaging label.

Find in C.1 section the keys for the mould codes and how to get the right number of tablets for each one.





B. How to make APLIWELD® exothermic welding

B.2 Procedure using the spark lighter

5 Set the starting powder.

Put 60% of the Starting Powder package contents from the edge of the mould to the crucible, providing a path of 5mm width approximately.

Sprinkle the remaining powder on the surface of the last tablet placed.

DO NOT pour the whole contents of the package on the tablet. It would make the ignition more dangerous and will damage the spark lighter (**AT-060N**). The powder path is aimed to provide an easy and safe ignition.

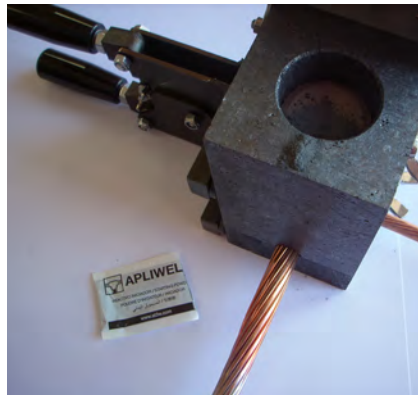

6 Close the mould cover.

The safety lever must be closed in order to avoid material leakages or sparks out of the mould coming from the cavity of Electronic Starter.



7 Ignite the Starting Powder using the Spark Lighter AT-060N.

Shoot the lighter pointing the starting powder wick.

Stand always aside or behind of the mould for avoiding damages caused by occasional material leakages.

Use **AT-060N** Spark lighter for the ignition in all cases.

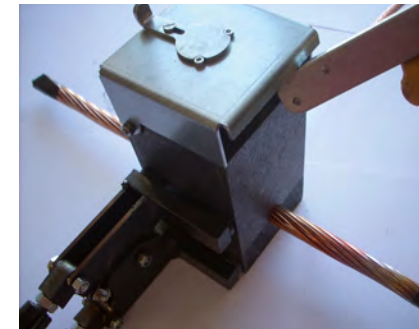

8 Keep away from the mould during the reaction.

Remain aside or behind of the mould during the welding process.



Never use a fire torch or any other flame device. Starting Powder ignites with sparks, never with flame.



B. How to make APLIWELD® exothermic welding

B.2 Procedure using the spark lighter

9

After the reaction, wait during 15 seconds and open the mould.

Wait 15 seconds before opening, assuring the melting of the materials.

Open the mould cover using the appropriate handle clamps and safety gloves, since the whole system is very hot. Keep extreme caution.

Take the welded conductors out of the mould.



10

Cleaning the mould.

Use the right cleaning tools to remove the slag and clean the crucible. **AT-064N** is the appropriate brush to clean the welding cavity. Use **AT-062N** brush to clean the mould cover, especially the Electronic Starter cavity.

Find a detailed description of cleaning tools and how to use them on section C.6 in this manual.

Once the mould is clean, there is no need to heat again the mould for a new welding if the new connection is made in the following 10-15 minutes.



All described cleaning tools are included in **AT-069N Tool Set**, except for the spark lighter **AT-060N**.

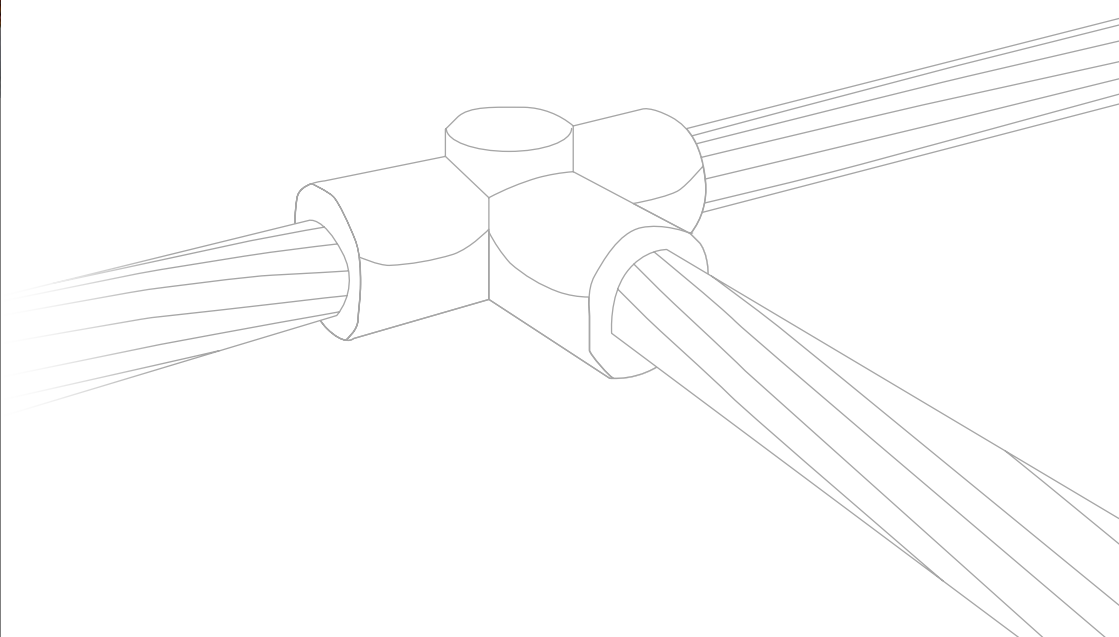



B. How to make APLIWELD® exothermic welding

B.3 Multiple mould. Procedure using electronic device APLIWELD® Secure+

1 Clean and remove any impurities off the mould or conductors.

Conductors and mould have to be clean and dry. This is very important to avoid rejectable welding and hazardous reactions (material leakages) when melting copper contacts moisture or impurities.

Clean conductors using **AT-061N** brush.

Check F.9, F.10, F.11 and F.12 in this manual for a particular surface or conductor cleaning indications.



2 Open the handle clamp and place the required lower piece.

The multiple mould box **MM-CTX** (where X is the rod diameter) contains the clamp (**MM-053N**) with the crucible and lower piece (**MM-PH**) already fixed:

- ▶ **MM-PH:** Lower piece for horizontal welding (T, cross, straight connections). This piece is placed in the multiple clamp for cable-to-cable connections. For tape to tape welding just turn the piece over.



- ▶ **MM-PTX:** for cable or tape to earth rod (usually T shape) The piece has the diameter of the earth rod according to the requirement (MM-PT14, MM-PT16...), working only for this specific rod diameter (see mechanized earth rod diameters on section C.2 in this manual).

For earth rod connections fix the stan plier clamp (**AT-082N**) 4 cm below the top of the rod. Open the lower part of the clamp **MM-053N** and place the **MM-PTX** piece, the one divided in two parts.

Put the multiple clamp over the stand plier and insert the earth rod in its place. Close the lower base of the clamp to fix tighten the graphite pieces to the earth rod thus avoiding material leakages in between the gasket.

Now the clamp should remain stable on the pliers, and both hands of the user free to place the rest of conductors easily.



AT-082N



B. How to make APLIWELD® exothermic welding

B.3 Multiple mould. Procedure using electronic device APLIWELD® Secure+

3 Heat the mould.

Heat the mould always before the first welding of the day or when the mould is not hot enough. Heat it up to 120°C to reach an acceptable result for first welding but also for the user security.

Moisture could cause material leakages out of the mould and pinholes in the welding result. Graphite gets moisture from the environment at ambient temperature, so it is necessary to heat it above water boiling point.

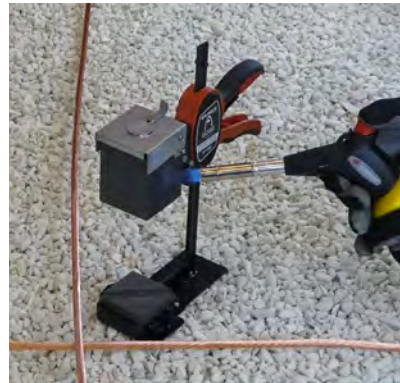

4 Place the lower cavity sealer (MM-CS), the conductors and all the other cavity sealers.

Place in the center of the lower piece of the mould a cavity sealer. Then put the conductor/s as the union type requires. Try to center as much as possible the conductors on the graphite piece. Over the conductors, place the correspondent cavity sealers as pointed in C.5.

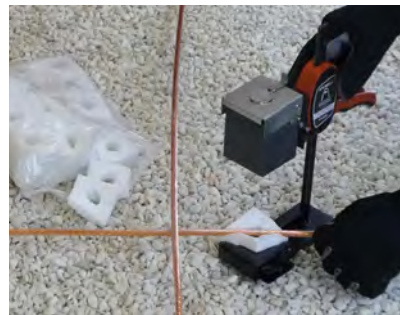

- ▶ **For T/straight welding**, just close the clamp squeezing down the crucible as much as possible to get a sealed system avoiding material leakages.
- ▶ **For cross welding** (conductor over conductor unions) repeat the previous steps setting over the last cavity sealer a new conductor and then 1-2 cavity sealers more according C.5. In all cases each conductor layer is wrapped between cavity sealers.

In order to know how many cavity sealers are advisable in a particular connection follow the table in C.5. (also included on each multiple mould set).

Place the metallic disc (find 10 units on each starting material box) in the hopper closing the tap hole. The number of tablets required for a particular connection is shown in C.5. table.

After closing the mould lid, place the Electronic Starter (**AT-010N**) case in its position and fix it using the security lever.

This security lever ensures good electrical contact and easy work conditions.

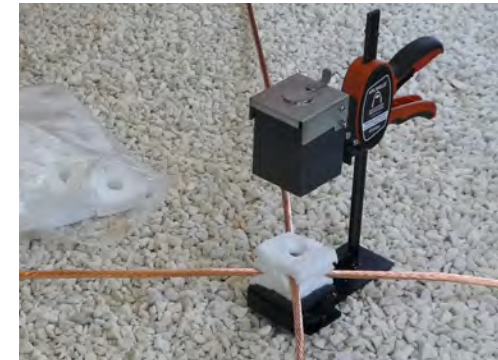



B. How to make APLIWELD® exothermic welding

B.3 Multiple mould. Procedure using electronic device APLIWELD® Secure+

5 Open the Ignition Unit and connect the plugs.

Connect the plugs in the device as showed in the picture. The Electronic Starter has no polarity so the order of connection is irrelevant. Connect the other side of the cable to the lateral part of the mould. Fix the clamp to the spike of the Electronic Starter.

The electric contact between the clamp and the spike is essential. The clamp must not touch any other part of the cover. If the clamp becomes worn, just replace it (**AT-100N kit APLIWELD®-E** includes 5 of these clamps).



6 Keep away from the mould and switch on the Ignition Unit.

Stay at least as far from the mould as the connection cable allows (2m). Switch on the device pressing On/Off button. A beep sound indicates it is ready. Then a green light signal is also displayed. In order to increase the security of the user, activate the remote-control device and wait until the blue light of the ignition device stops blinking, then the Bluetooth system is connected.



7 Press both ignition buttons simultaneously until the welding process starts.

Press both ignition buttons at the same time (either from the electronic device or the remote control) and keep both pressed till the reaction triggers on.

The welding in process indicator will light on and an audible alarm will activate: two beeps of approx. 3 seconds and then a continuous tone. During this last sound the welding reaction will ignite.

Consult section F.5 in case ignition doesn't occur.



B. How to make APLIWELD® exothermic welding

B.3 Multiple mould. Procedure using electronic device APLIWELD® Secure+

8 After the reaction, wait during 15 seconds and open the mould.

Wait 15 seconds before opening, assuring the melting of the materials.

Open the mould cover using the appropriate handle clamps and safety gloves, since the whole system is very hot. Keep extreme caution.

Take the welded conductors out of the mould.



9 Cleaning the mould.

Use the right cleaning tools to remove the slag and clean the crucible. **AT-064N** is the appropriate brush to clean the welding cavity. Use **AT-062N** brush to clean the mould cover, especially the Electronic Starter cavity.

Find a detailed description of cleaning tools and how to use them on section C.6 in this manual.



All cleaning tools are included in **AT-069N Tool Set**.

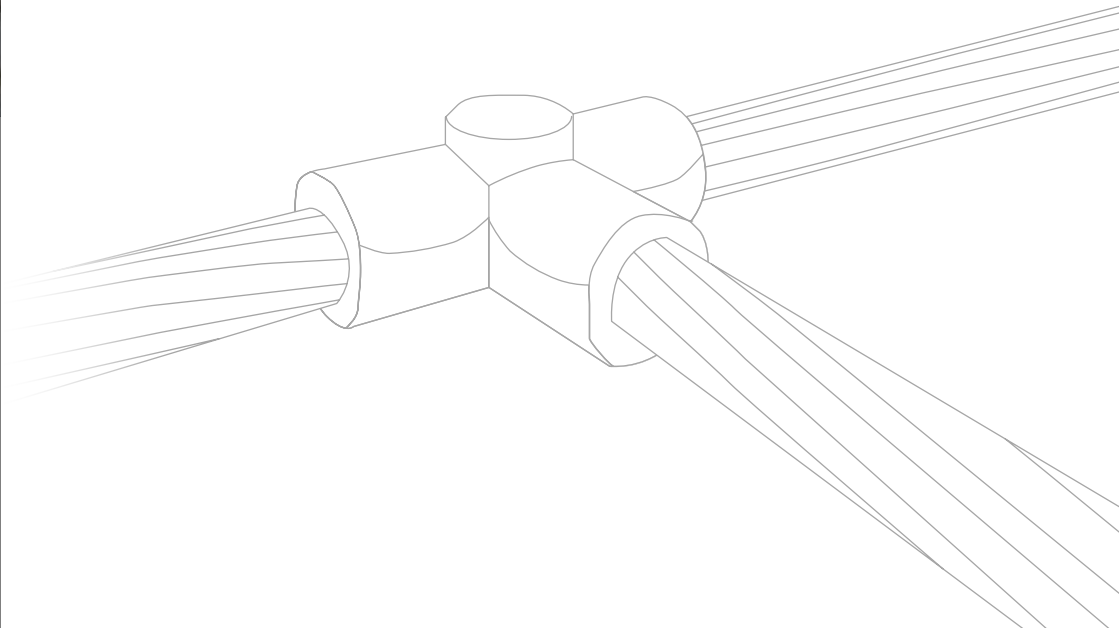



B. How to make APLIWELD® exothermic welding

B.4 Multiple mould. Procedure using the spark lighter

1 Clean and remove any impurities off the mould or conductors.

Conductors and mould have to be clean and dry. This is very important to avoid rejectable welding and hazardous reactions (material leakages) when melting copper contacts moisture or impurities.

Clean conductors using **AT-061N** brush.

Check F.9, F.10, F.11 and F.12 in this manual for a particular surface or conductor cleaning indications.



2 Open the handle clamp and place the required lower piece.

The multiple mould box **MM-CTX** (where X is the rod diameter) contains the clamp (**MM-053N**) with the crucible and lower piece (**MM-PH**) already fixed:

- ▶ **MM-PH:** Lower piece for horizontal welding (T, cross, straight connections). This piece is placed in the multiple clamp for cable-to-cable connections. For tape to tape welding just turn the piece over.



- ▶ **MM-PTX:** for cable or tape to earth rod (usually T shape) The piece has the diameter of the earth rod according to the requirement (MM-PT14, MM-PT16...), working only for this specific rod diameter (see mechanized earth rod diameters on section C.2 in this manual).

For earth rod connections fix the stan plier clamp (**AT-082N**) 4 cm below the top of the rod. Open the lower part of the clamp **MM-053N** and place the **MM-PTX** piece, the one divided in two parts.

Put the multiple clamp over the stand plier and insert the earth rod in its place. Close the lower base of the clamp to fix tighten the graphite pieces to the earth rod thus avoiding material leakages in between the gasket.

Now the clamp should remain stable on the pliers, and both hands of the user free to place the rest of conductors easily.



AT-082N



B. How to make APLIWELD® exothermic welding

B.4 Multiple mould. Procedure using the spark lighter

3 Heat the mould.

Heat the mould always before the first welding of the day or when the mould is not hot enough. Heat it up to 120°C to reach an acceptable result for first welding but also for the user security.

Moisture could cause material leakages out of the mould and pinholes in the welding result. Graphite gets moisture from the environment at ambient temperature, so it is necessary to heat it above water boiling point.

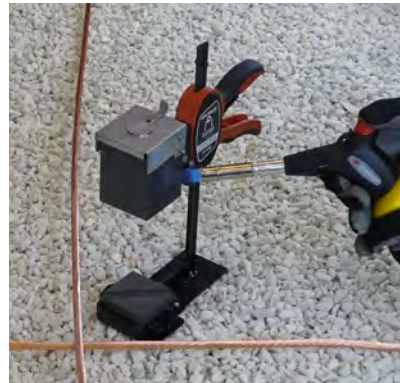

4 Place the lower cavity sealer (MM-CS), the conductors and all the other cavity sealers.

Place in the center of the lower piece of the mould a cavity sealer. Then put the conductor/s as the union type requires. Try to center as much as possible the conductors on the graphite piece. Over the conductors, place the correspondent cavity sealers as pointed in C.5.



- ▶ **For T/straight welding**, just close the clamp squeezing down the crucible as much as possible to get a sealed system avoiding material leakages.
- ▶ **For cross welding** (conductor over conductor unions) repeat the previous steps setting over the last cavity sealer a new conductor and then 1-2 cavity sealers more according C.5. In all cases each conductor layer is wrapped between cavity sealers.

In order to know how many cavity sealers are advisable in a particular connection follow the table in C.5. (also included on each multiple mould set).

Place the metallic disc (find 10 units on each starting material box) in the hopper closing the tap hole. The number of tablets required for a particular connection is shown in C.5. table.

After closing the mould lid, place the Electronic Starter (**AT-010N**) case in its position and fix it using the security lever.

This security lever ensures good electrical contact and easy work conditions.

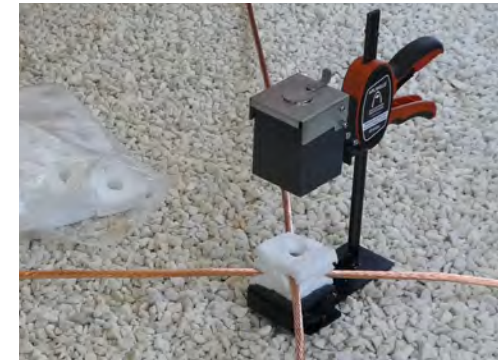



B. How to make APLIWELD® exothermic welding

B.4 Multiple mould. Procedure using the spark lighter

5 Set the starting powder.

Put 60% of the Starting Powder package contents from the edge of the mould to the crucible, providing a path of 5mm width approximately.

Sprinkle the remaining powder on the surface of the last tablet placed.

DO NOT pour the whole contents of the package on the tablet. It would make the ignition more dangerous and will damage the spark lighter (**AT-060N**). The powder path is aimed to provide an easy and safe ignition.



6 Close the mould cover.

The safety lever must be closed in order to avoid material leakages or sparks out of the mould coming from the cavity of Electronic Starter.



7 Ignite the Starting Powder using the Spark Lighter AT-060N.

Shoot the lighter pointing the starting powder wick.

Stand always aside or behind of the mould for avoiding damages caused by occasional material leakages.

Use **AT-060N** Spark lighter for the ignition in all cases.



8 Keep away from the mould during the reaction.

Remain aside or behind of the mould during the welding process.



Never use a fire torch or any other flame device. Starting Powder ignites with sparks, never with flame.



B. How to make APLIWELD® exothermic welding

B.4 Multiple mould. Procedure using the spark lighter

9 After the reaction, wait during 15 seconds and open the mould.

Wait 15 seconds before opening, assuring the melting of the materials.

Open the mould cover using the appropriate handle clamps and safety gloves, since the whole system is very hot. Keep extreme caution.

Take the welded conductors out of the mould.



10 Cleaning the mould.

Use the right cleaning tools to remove the slag and clean the crucible. **AT-064N** is the appropriate brush to clean the welding cavity. Use **AT-062N** brush to clean the mould cover, especially the Electronic Starter cavity.

Find a detailed description of cleaning tools and how to use them on section C.6 in this manual.



All described cleaning tools are included in **AT-069N Tool Set**, except for the spark lighter **AT-060N**.

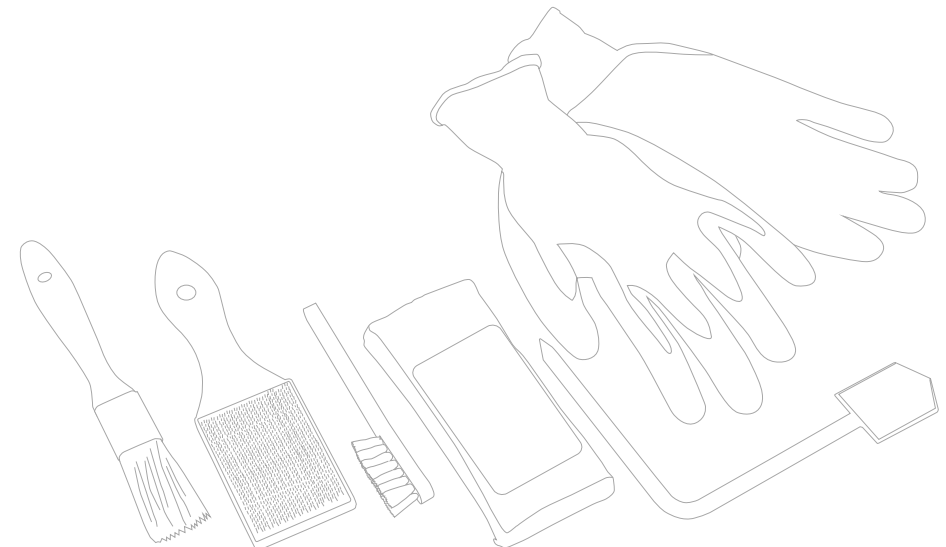



C. Moldes APLIWELD®

C.1 APLIWELD® mould codes and labelling

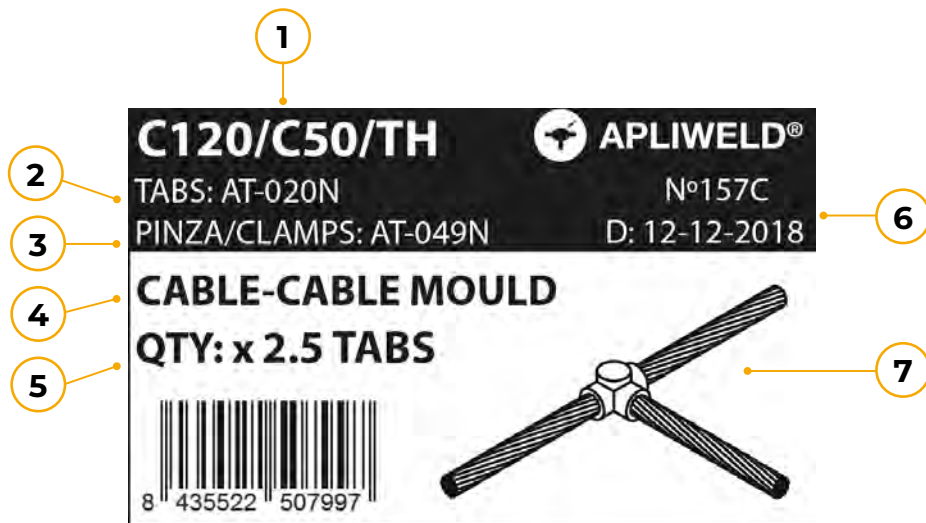

If this information is not found on the mould, do not use it and get in contact with our Technical Department for any question.

- 1 Mould reference (X/Y/Z) indicating the conductors involved and the union type:
 - ▶ X indicates the Conductor 1 dimensions and type.
 - ▶ Y indicates the Conductor 2 dimensions and type.
 - ▶ Z indicates the union type (TH: Tee horizontal, TV: Tee vertical, XH: Cross horizontal...).
- 1a For example, if a T-weld to a 120mm² runner cable is to be welded to a 50mm² cable, the mould reference will be **C120/C50/TH**.
- 1b For measurements in AWG, if an AWG 4/0 runner cable is going to be welded to an AWG 1/0 cable, the mould reference will be **W40/W10/TH**.
- 2 TABS: Tablet reference for this connection (**AT-020N** or **AT-021N** are the options).
- 3 PINZA/CLAMPS: The corresponding handle clamp reference for this particular mould. **AT-049N** is the most common but there are more references (**AT-050N** for bigger moulds, **AT-051N** for some vertical connections...).
- 4 Indicates the mould type according to UL486 standard.
- 5 QTY: Number of recommended tablets for this mould reference.
- 6 Reference code and batch number.
- 7 Weld result drawing.



C. APLIWELD® moulds

C.2 Conductors dimension tables

Find in the following tables the standard machined sizes for the conductors in APLIWELD® moulds. In this way, and in accordance to the table below, a mould for 50mm² cable it is always machined to 9mm, doing likewise with all the conductors.

Should you require a non-specified size or the conductor size is not the one showed in the table, please **give us the precise size of the conductor** to make it up to your particulars.

▶ C.2.1 Stranded copper cable

INTERNATIONAL METRIC SYSTEM			AWG SYSTEM		
CABLE/MM ²	CODE	MACHINED DIAMETER	CABLE/AWG	CODE	MACHINED DIAMETER
16mm ²	C16	4.5mm	2	W2	7.5mm
35mm ²	C35	7.5mm	1/0	W10	9mm
50mm ²	C50	9mm	2/0	W20	10.5mm
70mm ²	C70	10.5mm	3/0	W30	12mm
95mm ²	C95	12.5mm	4/0	W40	13.5mm
120mm ²	C120	14.5mm	250MCM	W250	14.5mm
150mm ²	C150	16mm	300MCM	W300	16mm
185mm ²	C185	18mm	350MCM	W350	17.5mm
240mm ²	C240	20mm	400MCM	W400	18.5mm
300mm ²	C300	22.5mm	500MCM	W500	21mm

▶ C.2.2 Steel re-bar

RE-BAR (DIAMETER)	CODE	MACHINED DIAMETER
10mm	V10	10,5mm
12mm	V12	13mm
16mm	V16	18mm
20mm	V20	22mm
25mm	V25	27mm

▶ C.2.3 Copper coated steel earth rods

For this conductors, the diameter and if the rod is end-threaded fixes the reference. So, if references of 2m lenght rod are taken, the mould code would be as follow:

EARTH ROD FEATURES			CODE	
REFERENCE (EARTH ROD 2m)	MIN. DIAMETER	THREAD	WELDING IN THE ROD-END	
			YES (TV, TT, TLV)	NO (XO, TO)
AT-041H	14.23mm (5/8")	YES	T16	T14
AT-072H	14.23mm (5/8")	NO	T14	T14
AT-042H	17.28mm (3/4")	YES	T19	T17
AT-082H	17.28mm (3/4")	NO	T17	T17

These tables are an abstract pf the most common references but there are more diameters particularly for the earth rods, especially when welding to galvanized or stainless earth rods.



C. APLIWELD® moulds

C.3 Basic tool set: AT-069N

Contents of the basic tool set **AT-069N**.

REFERENCE	DECRPTION	UNITS
AT-061N	Conductors cleanin brush	1
AT-062N	Crucible and cover (for electronic starter) cleaning brush	1
AT-063N	Slag removal spade	1
AT-064N	Welding cavity brush	1
AT-065N	Sealing paste	1
AT-073N	Working gloves	1



AT-069N



C. APLIWELD® moulds

C.4 Multiple mould box set compounds and spare parts

MM-CTX is the general reference for the multiple moulds, where “X” corresponds to the earth rod diameter selected (T14, T16...as showed in C.2).

Multiple mould set box contains:

CÓGIGO	DESCRIPCIÓN	UNIDADES
MM-053N	Multiple mould clamp	1
MM-T	Multiple mould crucible	1
MM-PTX	Lower part for earth rod with X diameter (*)	1
MM-PH	Lower part for cable and tape welding	1
MM-CS	Cavity Sealers (60 units)	2
AT-080N	Multiple mould case	1
AT-60N	Spark lighter (for powder starter)	1
AT-061N	Conductor cleaning brush	1
AT-062N	Crucible and electronic starter cavity cleaning brush	1
AT-063N	Slag removal spade	1
AT-064N	Welding cavity cleaning brush	1
AT-065N	Sealing paste to prevent material leaking	1
AT-073N	Safety gloves	1
AT-082N	Vertical stand pliers for earth rod welding	1

(*) X = 14, 16, 17, 18 and 19

- ▶ All pieces are available separately or as spare part.
- ▶ **MM-BTX** is also available. It only contains the multiple clamp, crucible and lower pieces.





Multiple mould box set





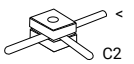

C. APLIWELD® moulds

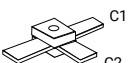
C.5 Connections with the multiple mould

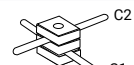

C.5.1 T horizontal

CONDUCTOR 1		CONDUCTOR 2		TABLETS	CS	ASSEMBLY
TYPE	MAX. SIZE	TYPE	MAX. TYPE			
CABLE	70mm ² (2/0 AWG)	CABLE	70mm ² (2/0 AWG)	2	2	
CABLE	95mm ² (3/0 AWG)	CABLE	95mm ² (3/0 AWG)	2.5	4	
TAPE	ALL	TAPE	ALL	2	2	

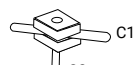

C.5.1 Cross

CONDUCTOR 1		CONDUCTOR 2		TABLETS	CS	ASSEMBLY
TYPE	MAX. SIZE	TYPE	MAX. SIZE			
CABLE	70mm ² (2/0 AWG)	CABLE	50mm ² (2/0 AWG)	2	3	
CABLE	70mm ² (3/0 AWG)	CABLE	70mm ² (3/0 AWG)	2.5	4	
CABLE	95mm ² (3/0 AWG)	CABLE	95mm ² (3/0 AWG)	2.5	6	
TAPE	ALL	TAPE	ALL	2	3	

C.5.3 T vertical

CONDUCTOR 1		CONDUCTOR 2		TABLETS	CS	ASSEMBLY
TYPE	MAX. SIZE	TYPE	MAX. SIZE			
CABLE	70mm ² (2/0 AWG)	CABLE	ALL	2	2	
CABLE	95mm ² (3/0 AWG)	TAPE	ALL	2.5	4	

C.5.4 Lineal

CONDUCTOR 1		CONDUCTOR 2		TABLETS	CS	ASSEMBLY
TYPE	MAX. SIZE	TYPE	MAX. SIZE			
ANY	ALL	ANY	ALL	2	2	
CABLE	95mm ² (3/0 AWG)	ANY	ALL	2	2	

- ▶ CS = Cavity Sealers.
- ▶ For re-bar connections use the following equivalence: C70 = V10, C95=V12.
- ▶ For cable to tape joints, tape is equivalent to "Cables up to 50mm²".
- ▶ Parallel connections are possible for cables up to 50mm². They all require 2.5 tablets with 1+2+2 CS.
- ▶ For any other required but not described connection, please consult us.



C. APLIWELD® moulds

C.6 Cleaning and maintenance

At the end of the welding process, an adequate cleaning increases the mould life and prepares it for the following welding. Take care in this step; the mould is still very hot.

- 1 Remove the slag in the crucible using slag removal spade (**AT-063N**), screwing down to scrape it off. If slag persists, a hammer could help. Handle with care not to damage the mould.
- 2 Use **AT-062N** cleaning brush after for a complete cleaning of the crucible. This tool is also suitable for cleaning the cover in the electronic starter holding place. Do not use this tool to clean the welding cavity.
- 3 Clean welding cavity, tap hole and conductors location using **AT-064N** brush.
- 4 Check the mould is already clean, with no impurities and with correct open and close movements.
- 5 All these cleaning items are included in the set **AT-069N** (see C.3).



Once these cleaning steps are done, the mould is prepared for a new welding.



AT-061N

AT-062N

AT-063N

AT-064N



C. APLIWELD® moulds

C.7 Inspection

The first step for obtaining correct welding is keeping the mould in best conditions.

The mould should work among 50 to 70 weldings in average, which can vary depending on the user's care, working conditions or the union type and the conductors involved.

Check the mould regularly. Replace it if becomes worn. Assess the following points to decide if the mould has to be replaced:

- 1 **Defects in the crucible:** Clean the crucible using the proper cleaning tools (**AT-062N** y **AT-063N**) in order to place the tablets easily. There is no need of metallic disk for the tap hole so no special cleaning tool is required.
- 2 **External surface defects:** Damages on the external surface of the mould do not affect the final result if they don't affect the structure or the adjustment of the clamp.
- 3 **Defects in the cable location:** Clean this part using **AT-064N** brush. Conductors must readily fit in there before closing the mould. Once closed, the clamp fixes them tight.
- 4 **Defects in the welding cavity:** This is the most sensitive area in the mould. Its erosion or manipulation can cause material leakages or a badly molten metal distribution. Use **AT-064N** brush to clean the cavity. Any other cleaning tools could damage this mould part.

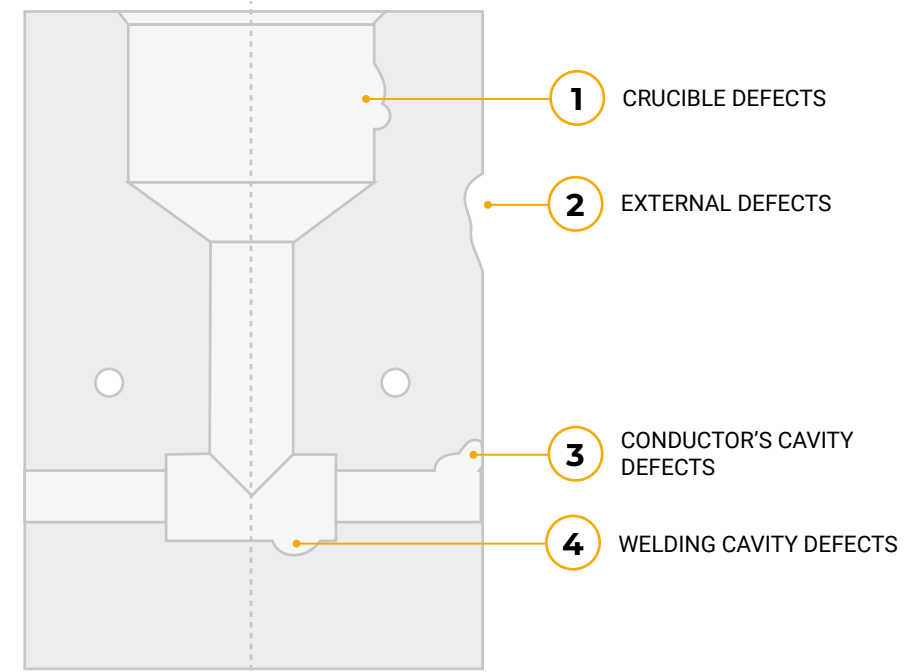

Remember that the sections of the conductors are the marked on the mould. Consider also, the right diameter for the section. Otherwise use **AT-072N** Adapter Sleeves in case of cables. Conductors must keep a convenient shape with no deformation, allowing the correct closure of the mould/clamp system.



D. APLIWELD® tablets and consumables

D.1 Tablets and ignitors

There are two formats for **APLIWELD®-T**:

- ▶ **AT-020N:** Standard tablets, 45 grams (43mm diameter), supplied in 20 unit packages. Tablets can be halved if needed (for instance, when 2.5 tablets are required for a connection).
- ▶ **AT-021N:** Large tablets, 100 grams (55 mm diameter), supplied in 20 unit packages. These are recommended for bigger conductors, such as cables with more than 150 mm² section of tapes larger than 4 x 5 mm. Using larger tablets for these connections economizes preparation times and mould costs.

Tablets do not include starting powder or electronic starter because the ignition might be either electronic or using the starting powder.

These are the two **APLIWELD®** ignition formats:

- ▶ **AT-010N:** 10 Electronic starters to carry out the ignition using **AT-100N** ignition including also 10 metallic disks.
- ▶ **AT-012N:** 10 Starting powder units for ignition using **AT-060N** spark lighter including also 10 metallic disks.

In both cases, regardless the number of tablets required for a connection, only one starter per welding is needed.

For the right tablet reference and the number of tablets in a connection, consult our technical webpage, ask for the **APLIWELD® Secure+ Selector** or consult with our customer service.



AT-020N and AT-021N



AT-010N



AT-012N

E. Welding check-up

E.1 Acceptable or unacceptable results

In order to meet the requirements for an acceptable welding, the mould must be clean, with cavities for cables and welding well defined so the conductor and clamp would fit easily.

The conditions to validate a welding are:

- ▶ The molten material should completely cover the limits of the welding cavity or at least the thickness the conductors had initially, in order to keep its previous section.
- ▶ The result should not present superficial porosity of a depth of more than 1mm.
- ▶ Welding result should be free of slag, accomplishing all the preceding conditions.
- ▶ The color of the welding varies from gold to bronze once cleaned.

Therefore, perfect welding shows a solid, gold to bronze appearance, covering the whole surface of the conductor within the welding cavity and with fewer imperfections.

A welding can be unacceptable for different reasons ranging from the inadequate use of the welding mixture packaging to faults in the structure of the mould.

The inspection of the most usual defects in the graphite mould and in the welding itself, indicate the causes of the faults and how to prevent them happening again.





F. FAQ's and resolution tips



F.1 Pinholes in the welding surface

CAUSE	Moisture or impurities in the conductors and/or in the mould.	
SOLUTION	Heat the mould again. Clean and remove all oil or combustible material as well as galvanized, strips, adhesives... from the conductors.	

F.2 Lack of welding

CAUSE A	The tension on the cables may separate them when the welding melts (and then cuts) the conductors. This enlarges the welding cavity so more welding material is required to fill it up.	 AT-059N
SOLUTION	Use AT-059N holding cable clamps to fasten the conductors.	
CAUSE B	Welding material leakages.	
SOLUTION	Check the mould as in section C.4. See also F.3.	
CAUSE C	Wrong tablet selection. The mould requires more tablets than used.	
SOLUTION	Check the mould label or reference engraved. If any doubt do not hesitate to consult us.	

F.3 Material leakages through the conductors

CAUSE	Cable mould opening becomes worn or the cable size is smaller than required.	
SOLUTIONS	<p>1. Use Sealing paste around the cable cavities once the mould is locked. Sealing paste never has to be applied inside the welding cavity.</p> <p>When the mould becomes worn, the use of sealing paste is only recommended when a few connections remain to end the work: It takes more time to prepare than a regular joint and the mould won't last for longer.</p> <p>References are:</p> <ul style="list-style-type: none"> ▶ AT-065N: 0.5kg ▶ AT-066N: 1kg ▶ AT-071N: 2.25kg 	 AT-066N
	<p>2. Use cable adapters (AT-072N). These are 0.3 mm thick copper sleeves to wrap the conductors enlarging their diameters to shim the conductors to de mould. This solution is also only recommended when few connections are required, because it takes longer time to prepare the conductors</p>	 AT-072N
	<p>3. Replace the mould.</p>	



F. FAQ's and resolution tips

F.4 Large slag amounts stuck to the welding surface

It is important to distinguish between superficial slag over the welding and slag over the conductor.

- ▶ After removing the slag, if there is welding material below, then the result is correct provided that general conditions are accomplished. In this case is just superficial slag.
- ▶ But if behind the slag the conductors are not melted, then the result is rejectable and the cause could be as follows:



CAUSE A	Wrong tablet selection. The mould requires more tablets than used.
SOLUTION	Check the mould label or the reference engraved. If any doubt do not hesitate to consult us.

CAUSE B	Welding material leakages.
SOLUTION	Check the mould as in section C.4. See also F.3.

F.5 Electronic ignition trouble-shooting

- ▶ F.5.1 The power button (ON) does not light up and there is no beep sound indicating that it is ready

CAUSE	Battery is not loaded or is exhausted.
SOLUTION	Charge the battery at least during 10 hours and check that the ON button is right. Start the working time with this marker always lit.

- ▶ F.5.2 When the two ignition buttons are pressed, there is no beep sound and the process does not start

CAUSE A	The two ignition buttons have not been pressed simultaneously.
SOLUTION	Press the buttons again, assuring that they are pressed simultaneously.

CAUSE B	Low battery.
SOLUTION	Charge the battery.

- ▶ F.5.3 When the two ignition buttons are pressed, there is beep sound but the process does not start

CAUSE	Connections cable-clamp-electronic starter are not correct.
SOLUTIONS	1. Verify all the connections and substitute the clamp if necessary.
	2. Clean the connections and substitute the clamp if necessary.
	3. Adjust the closing of the electronic starter.



F. FAQ's and resolution tips

F.6 Spark lighter ignition problems

▶ F.6.1 I do not have a spark lighter

Get a spark lighter to carry out the ignition (**AT-060N**).

▶ F.6.2 Spark lighter doesn't work

CAUSE A	The end of the igniter is blocked.
SOLUTION	Clean the flint igniter immersing the end in ammonia during 8 hours.
CAUSE B	The flint in the igniter is worn.
SOLUTION	Change the flint placing a new one. The reference AT-070N contains 10 units of these recharges.
CAUSE C	Others.
SOLUTION	Change the spark lighter.



Do not use torch, matches or any other flame tool for ignition.

The following images show the correct use of the Spark Lighter.
This proper use will enlarge its working life.

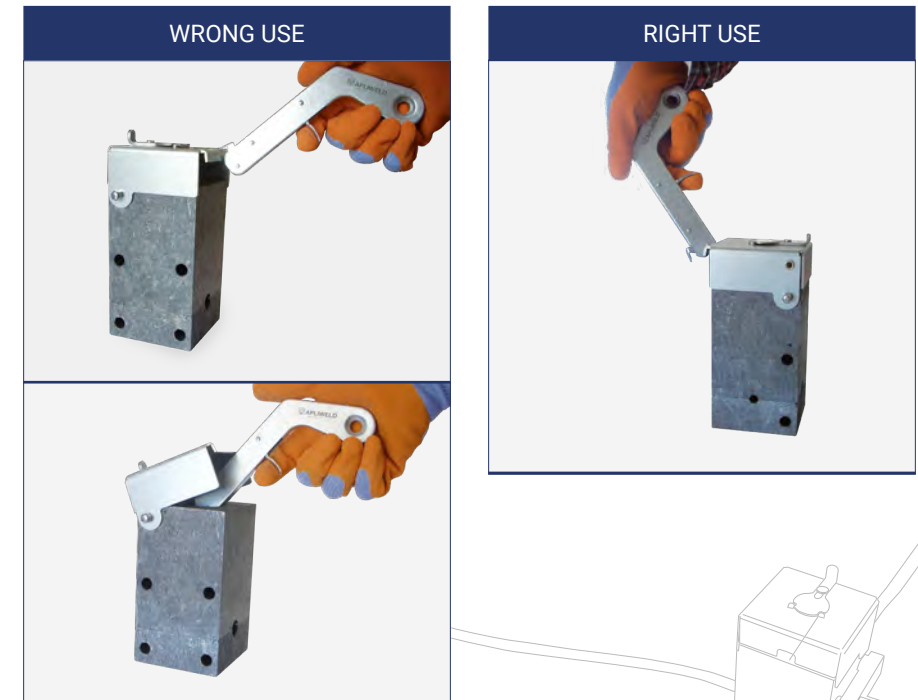



F. FAQ's and resolution tips

F.7 Clamps do not lock correctly the mould

CAUSE	Clamps do not press with enough strength.
SOLUTIONS	1. Remove the key and pin in the adjustment linkage to balance locked strength.
	2. Remove remaining slag or any other object if it blocks the correct clamp closure.
	3. If the conductor is bended, straighten it. Check if you are using the right conductor for the mould.



Adjustment wing screw in AT-049N and AT-050N clamps

F.8 Correspondence between AT-020N tablets and traditional welding material

Other brands use, as consumables, welding material in powder in 10 cartridge units, containing 32, 45, 65, 90, 115, 150, 200, 250 grams. Each mould is related to one of these charges.

CHARGES (gr)	NR OF TABLETS
32	1
45	1
65	1.5
90	2
115	2.5
150	3.5
200	4.5
250	6

A relationship can be established between each of these cartridges and the equivalent number of **APLIWELD®-T** tablets (reference **AT-020N**). Equivalences are an approximation, since they are related to other brand's mould designs.

The correct procedure for assuring the accurate welding compound is asking for **APLIWELD®** moulds, indicating the estimated number of weldings to be made with each mould. Thus, using our web site, our catalogue or our friendly **APLIWELD® Secure+ Selector** calculation program, the number of tablets and all the recommended material are correctly obtained.

- ▶ More information about the reference selector **APLIWELD® Secure+ Selector**: <https://at3w.com/en/smart-earthing/apliweld-secure-exothermic-welding/graphite-moulds/specific-moulds/>
- ▶ Download **Software Apliweld Selector**: <https://at3w.com/Descargas/ApliweldSetup.zip>



F. FAQ's and resolution tips

F.9 Metallic surface connections

Before making a connection, the surface must be clean, rust free, heated and flat.

Remove the rust layer, grease or painting using the right brush or better a grinder, to let the bright metal thus making easier the connection.

In galvanized surfaces remove the galvanic layer of the connection point. Use a galvanizing spray after the connection if "bright metal" still stands in some points.



F.10 Re-bar connections

The irregular shape of re-bar rods causes slight leakages from the mould even if it is locked tight.

Wrap the rebar using sealing paste once the mould is well-locked.



F.11 Vertical re-bar connections

It is possible to carry out vertical re-bar connections using specific moulds for each cable size and rebar diameter. But there's another way to make these connections using cable to vertical surface moulds (**VPH** or **VTB** types) together with rebar **AVX** accessories (where X is the diameter of the rebar). This method uses **AT-051N** clamp.

E.g.: Welding 50mm² cable to 20mm vertical re-bar.

- ▶ Mould **C50/M/VPH**.
- ▶ Accessory **AV20**.
- ▶ Clamp **AT-051N**.
- ▶ 2 tablets **AT-020N**.
- ▶ Sealing paste **AT-066N**.

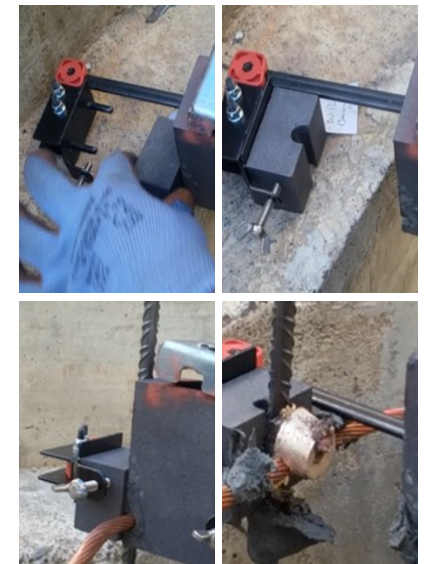

The key of this versatile method is to change the AVX accessories for the rebar (or earth rod) and the VPH mould depending on the connection required. This is quite a multiple mould concept because using a relatively small quantity of pieces, many different connections are possible.



F. FAQ's and resolution tips

F.12 Otras impurezas del material

Remove all the impurities in mould and conductors.

- ▶ **Mud impurities:** Remove using AT-061N and wiping the conductor with a dry cloth before heating with a torch.
- ▶ **Grease, fuels, oils impurities...:** Remove using a torch o using an adequate dissolvent. Heat after applying it.
- ▶ **Rust and painting impurities:** Remove all these impurities because the welding won't "stick" to this kind of oxides...
- ▶ **Other impurities:** Any other burning material like paper, adhesive strip must be out of the mould to avoid flames to damage final results.

In case of unknown materials if any doubt, do not hesitate to contact us before making the connection.



WARNING

Check the working area to assure a convenient surrounding to use the torch and carry out the welding reaction.



AT-061N





G. Reference index and APLIWELD® common product codes

More than 600 **APLIWELD®** references are available to consult in our catalogue and website. This point lists those being most demanded:

APLIWELD® SECURE+ PRODUCTS		
REFERENCE	DESCRIPTION	MORE INFORMATION
AT-020N	APLIWELD®-T: exothermic welding tablets (20 Un.)	See section D.1
AT-010N	APLIWELD®-E: electronic starter (10 Un.)	See section D.1
AT-021N	APLIWELD®-T: exothermic welding tablets 55mm (20 Un.)	See section D.1
AT-100N	Kit APLIWELD®-E: electronic starting device including the Ignition Unit (AT-114N), connection cable (AT-098N), 5 connection clamps (AT-099N), battery charger and a portable bag	See section B.1 step 6
AT-069N	Basic Tool Kit	See section C.3

OTHER APLIWELD® PRODUCTS COMPATIBLES WITH APLIWELD® SECURE+		
REFERENCE	DESCRIPTION	MORE INFORMATION
AT-012N	Starting powder (10 Un.)	See section D.1
AT-065N	Sealing paste 0.45 kg	See section C.3
AT-060N	Spark lighter	See section C.4
AT-061N	Conductors cleaning brush	See section F.9
AT-072N	Adapter sleeves (25 Un.)	See section F.3
AT-059N	Conductors clamp	See section F.2

MULTIPLE MOULD		
REFERENCE	DESCRIPTION	MORE INFORMATION
MM-053N	Multiple mould clamp	See section B.3 step 2
MM-CS	Cavity sealer (60 Un.)	See section C.4



AT-020N/021N | Section D.1



AT-010N | Section D.1



AT-100N | Section B.1 step 6



AT-069N | Section C.3



AT-012N | Section D.1



AT-065N | Section C.3



AT-060N | Section C.4



AT-061N | Section F.9

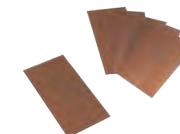

AT-072N | Section F.3



AT-059N | Section F.2



MM-053N | Section B.3 step 2



MM-CS | Section C.4



G. Reference index and APLIWELD® common product codes

	SPECIFIC MOULD		DESCRIPTION
	MM ²	AWG	
1	C50/T14/TV	W10/T14/TV	50 mm ² cable (run) (1/0 AWG) with ø14.3 mm earth rod (tap), vertical T
	C50/T16/TV	W10/T16/TV	50 mm ² cable (run) (1/0 AWG) with ø15.9 mm earth rod (tap), vertical T
	C70/T14/TV	W20/T14/TV	70 mm ² cable (run) (2/0 AWG) with ø14.3 mm earth rod (tap), vertical T
	C70/T16/TV	W20/T16/TV	70 mm ² cable (run) (2/0 AWG) with ø15.9 mm earth rod (tap), vertical T
	C95/T14/TV	W30/T14/TV	95 mm ² cable (run) (3/0 AWG) with ø14.3 mm earth rod (tap), vertical T
	C95/T16/TV	W30/T16/TV	95 mm ² cable (run) (3/0 AWG) with ø14.3 mm earth rod (tap), vertical T
2	C35/C35/TH	W2/W2/TH	35 mm ² cable (run) (2 AWG) with 35 mm ² cable (tap), horizontal T
	C50/C50/TH	W10/W10/TH	50 mm ² cable (run) (1/0 AWG) with 50 mm ² cable (tap), horizontal T
	C70/C70/TH	W20/W20/TH	70 mm ² cable (run) (2/0 AWG) with 70 mm ² cable (tap), horizontal T
	C95/C95/TH	W30/W30/TH	95 mm ² cable (run) (3/0 AWG) with 95 mm ² cable (tap), horizontal T
	C120/C120/TH	W40/W40/TH	120 mm ² cable (run) (4/0 AWG) with 120 mm ² cable (tap), horizontal T
	C150/C150/TH	W300/W300/TH	150 mm ² cable (run) (300MCM) with 150 mm ² cable (tap), horizontal T
3	C35/C35/XS	W2/W2/XS	35 mm ² cable (2 AWG) over 35 mm ² cable, cross
	C50/C50/XS	W10/W10/XS	50 mm ² cable (1/0 AWG) over 50 mm ² cable, cross
	C70/C70/XS	W20/W20/XS	70 mm ² cable (2/0 AWG) over 70 mm ² cable, cross
	C95/C95/XS	W30/W30/XS	95 mm ² cable (3/0 AWG) over 95 mm ² cable, cross
	C120/C120/XS	W40/W40/XS	120 mm ² cable (4/0 AWG) over 120 mm ² cable, cross
	C150/C150/XS	W300/W300/XS	150 mm ² cable (300MCM) over 150 mm ² cable, cross
4	C35/M/VPV	W2/M/VPV	35 mm ² cable (2 AWG) over vertical surface mould
	C50/M/VPV	W10/M/VPV	50 mm ² cable (1/0 AWG) over vertical surface mould
	C70/M/VPV	W20/M/VPV	70 mm ² cable (2/0 AWG) over vertical surface mould
5	P302/T14/TV	P302/T14/TV	30x2 mm tape (run) with ø14.3 mm earth rod (tap), vertical T
	P302/T16/TV	P302/T16/TV	30x2 mm tape (run) with ø15.9 mm earth rod (tap), vertical T
6	P302/P302/XS	P302/P302/XS	30x2 mm tape over 30x2 mm tape, cross
7	C50/P302/LH	W10/P302/LH	50 mm ² cable (1/0 AWG) with 30x2 mm tape, straight horizontal
8	C50/M/VTH	W10/M/VTH	50 mm ² cable-end (1/0 AWG) to horizontal surface mould
9	V12/C50/TO	V12/W50/TO	ø12 mm re-bar (tap) with 50 mm ² cable (tap) (1/0 AWG), 90° T

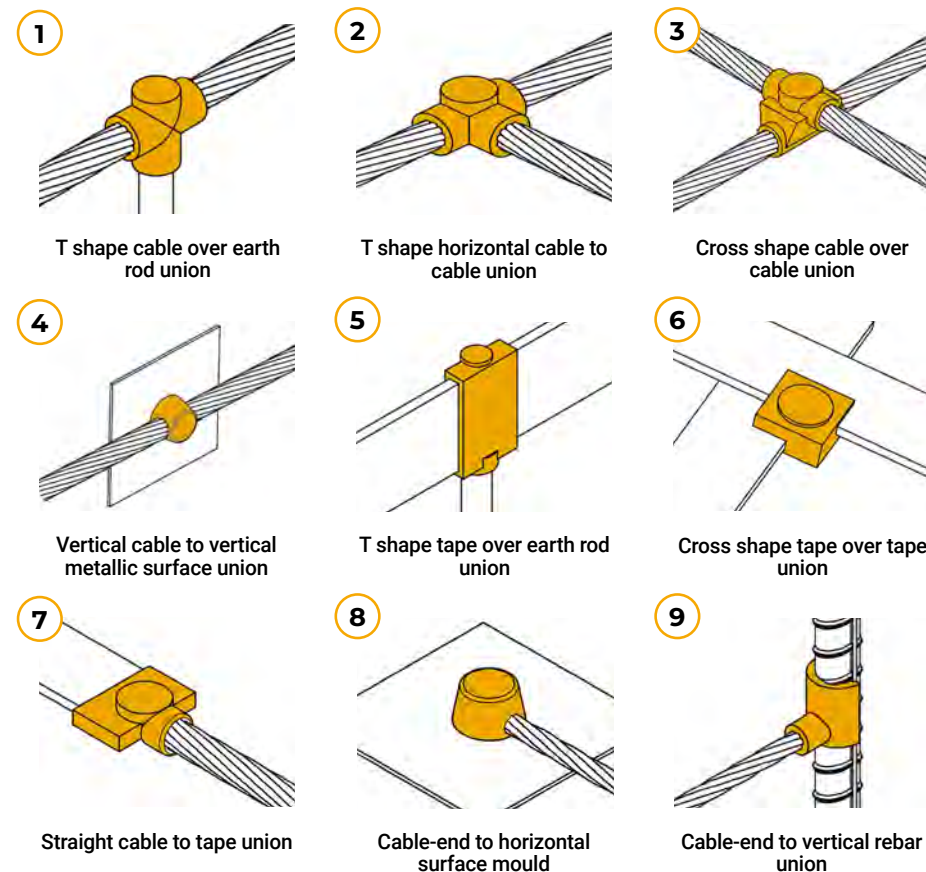

For a suitable mould, tablets and accessories selection, consult our catalogue, website or directly our technical department. If any doubt, do not hesitate to contact us.



H. Environment

H.1 Indications for use and recommendations for recycling equipment lead batteries electronic ignition AT-114

- ▶ **During the accumulator recharging process, the unit switches off automatically.** Respect the charging times and do not use the unit during this process.
- ▶ **Use the chargers provided by the manufacturer** avoiding fire hazards if charging the accumulator with other kind of them.
- ▶ **Keep the accumulator stored far from clips, coins, keys... or any other metallic objects to avoid bypassing.** Accumulator short circuits may cause fire hazards and burns.
- ▶ **Take steps to avoid leakage of liquid from the battery.** Avoid direct contact in case of accidental spillage. In case of direct contact wash with water, if persist seek for medical attention. The battery liquid could cause skin irritation and burns.
- ▶ **Disposal measures:** Electric tools accessories and packages should be disposed for recycling always respecting the environment.

As a company committed to the environment, we are responsible to dispose all accumulators and consoles according with local and European environmental regulations (2002/96/CE).

▶ Accumulators/batteries:

! WARNING

Accumulators may contain toxic materials (Lead, sulphuric acid).

Electrolyte contains sulphuric acid which is corrosive and may cause burns.

Accumulators must be stored for recycling or environmental approved disposal.





i. Warnings, guarantees & limitation of liability

i.1 Warnings

APLIWELD® products shall be installed and used only as indicated in particular instructions of use sheets or in this manual, download available at **www.at3w.com**. Improper installation or use, misapplication or other failure to completely follow **APLIWELD®** instruction and warnings may cause product malfunction, property damage, serious bodily injury...

Store **APLIWELD®** product in a safety clean a dry place, far from ignition sources like sparks, heating devices o electric discharges. Avoid strong vibrations and prevent any rough handling or physical damage.

Under these storage conditions, no expiration rate known for the products.

Consult Material Safety data Sheets for a more detailed information and product properties.

i.2 Guarantee

APLIWELD® products are warranted to **APLICACIONES TECNOLÓGICAS S.A.**, owner of the brand, be free from defects in material and workmanship at the time of shipment. No other warranty, whether express or implied, including any warranty do merchantability or fitness for a particular purpose, shall exist in connection with the sale or use of **APLICACIONES TECNOLÓGICAS S.A.**

Claims for errors, or nonconformities must be made in writing and returned to **APLICACIONES TECNOLÓGICAS S.A.** for inspection, prior written approval in accordance with its standard terms and procedures. **APLICACIONES TECNOLÓGICAS S.A** shall in no event be responsible if the products have not been stored or used in accordance with its specifications and recommended procedures. **APLICACIONES TECNOLÓGICAS S.A** will, at its option, either repair or replace nonconforming or defective products for which it is responsible or return the purchase price to the customer.

i.3 Limitation of liability

Should APLICACIONES TECNOLÓGICAS S.A. be held liable its liability shall in no event exceed the total purchase price under the contract. APLICACIONES TECNOLÓGICAS S.A shall no event responsible for any loss of business or profits, downtime of delay, labor, repair or material costs or any similar or not consequential loss or damage included by buyer.

As a consequence of our continuous development and investigation politics, all specifications and products are subject to change without notice.

APLIWELD® is a registered trademark of APLICACIONES TECNOLÓGICAS S.A.

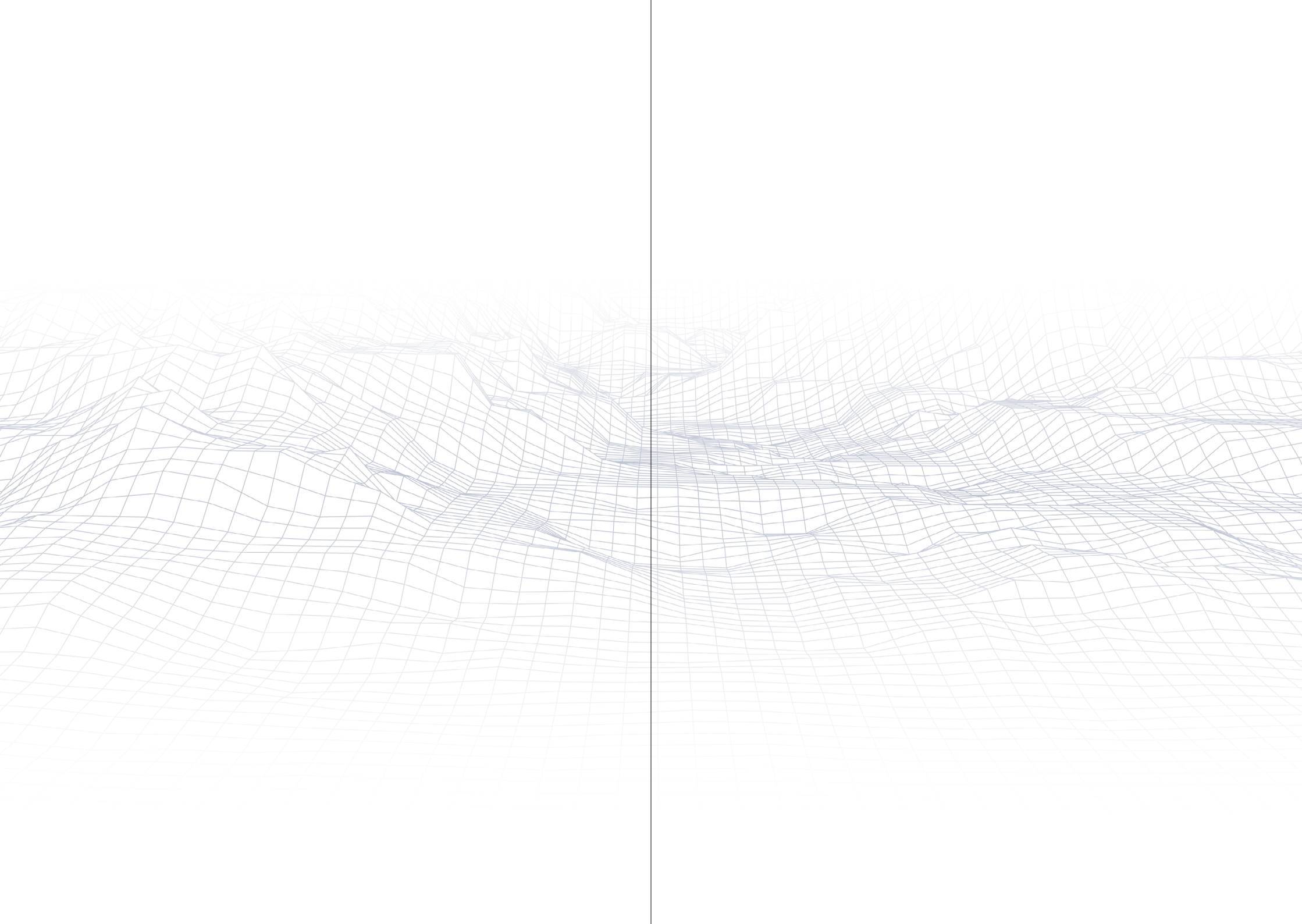

APLICACIONES TECNOLÓGICAS S.A.

Parque Tecnológico de Valencia

 C/Nicolás Copérnico, 4 - 46980 Paterna (Valencia), SPAIN

 (+34) 961 318 250  atsa@at3w.com  at3w.com

